

# The Custom Boxes – Design Customized Packaging & Printed Boxes with Logo

---

 thecustomboxes.com/



## Worth-Ravishing Custom Retail Boxes

---

Conquer the retail world with customized packaging, bestowing a new shelf life to your products.

[Choose your packaging style](#)



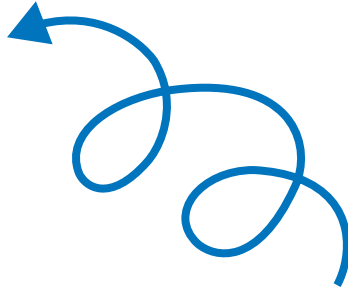

## Worth-Ravishing Custom Eco Friendly Boxes

---

Sustainable, recyclable, and biodegradable boxes – eco-friendly personalized packaging echoes the ethos of nature conservation

[Choose your packaging style](#)



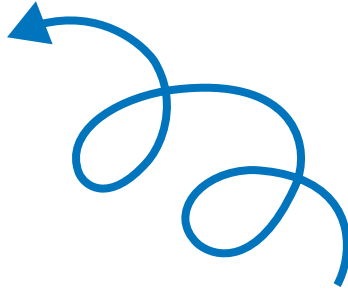

## Worth-Ravishing Custom Cardboard Packaging

---

Vibrant colors, subtle prints, and stunning appeal blend seamlessly with the lightweight cardboard box, making it an ideal branding tool.

[Choose your packaging style](#)



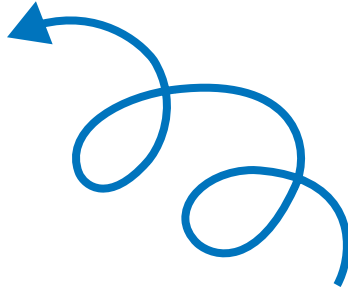

## Worth-Ravishing Custom Rigid Boxes

---

Premium rigid boxes are a must-have luxury product accessory; they exude class and elegance, complemented by an iconic appeal.

[Choose your packaging style](#)





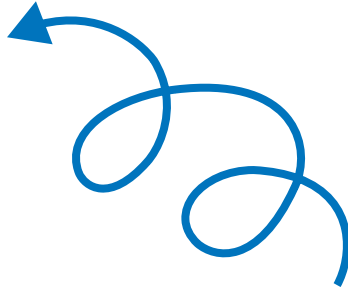

## Custom Boxes and Packaging in 4 steps:

---

The Custom Boxes printing experts know what the worst mistakes they can ever commit. Luckily, they are also familiar with how to eliminate it. From dimensions to cuts, and die treatment to interlocking, they have mastered every skill. So, lay the foundation of exceptional boxes on unparalleled structural designs.

- Offer Diverse Designs And Patterns
- Functional Minimalism With Full Box Customization
- Unique Cuts To Create Memorable Designs
- Practical Design Makes Your Box All-Purpose Marketing Tool
- Examples Of Great Structural Designs Include A Tuck End, Auto Lock, Tray And Sleeves, And Double-Walled Tuck Front.



Design of custom boxes, if well-generated, are made to get additional benefits. To make a box more than a protective covering, we hide advertising strategies as extras. Design one-to-one with our expert designers to create wonderful packaging for business purposes.

- One-Of-A-Kind Graphic Designer Creates Trendy Boxes
- Make The Best Use Of Every Line And Dot To Deliver Masterpiece
- Great Overall Appeal And Feel Of The Final Package
- Spark Sense Of Excitement In Viewer's Eye

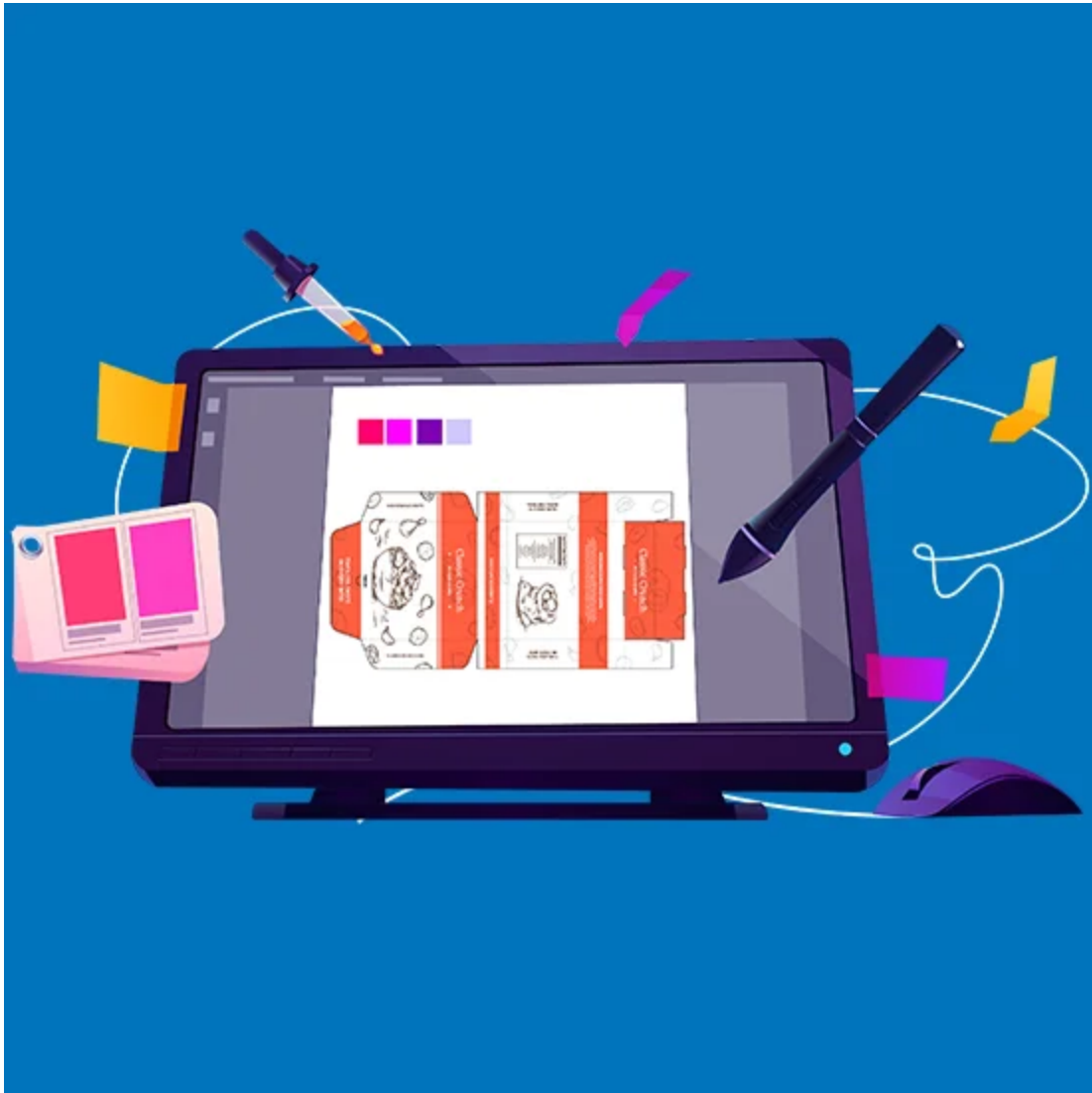

Prototyping is the art of transferring your ideas on the canvas of your custom packages, as a template or sample. We help you visualize what will be the final upshot, before hitting the mass production. It saves time and resources.

- Unlock Possibilities To See The Final Outlook Before Time
- Allow Customers To Build A Box With Real-Time Sampling Support
- Reconsider Your Vague Ideas And Go For The Best Packaging Solution
- Confidently Start The Customization Of Packaging Box



The last and foremost important step is to strive for excellence while guaranteeing precision in high-volume production. At The Custom Boxes, the quality is assured in six phases including, artwork approval, CTP plate making, printing, and lamination, die-cutting, finishing, and pasting. Get Custom packaging boxes now!

- Offer Diverse Designs And Patterns
- Functional Minimalism With Full Customization
- Unique Cuts To Create Memorable Designs
- Practical Design Makes Your Box All-Purpose Marketing Tool
- Examples Of Great Structural Designs Include A Tuck End, Auto Lock, Tray And Sleeves, And Double-Walled Tuck Front.

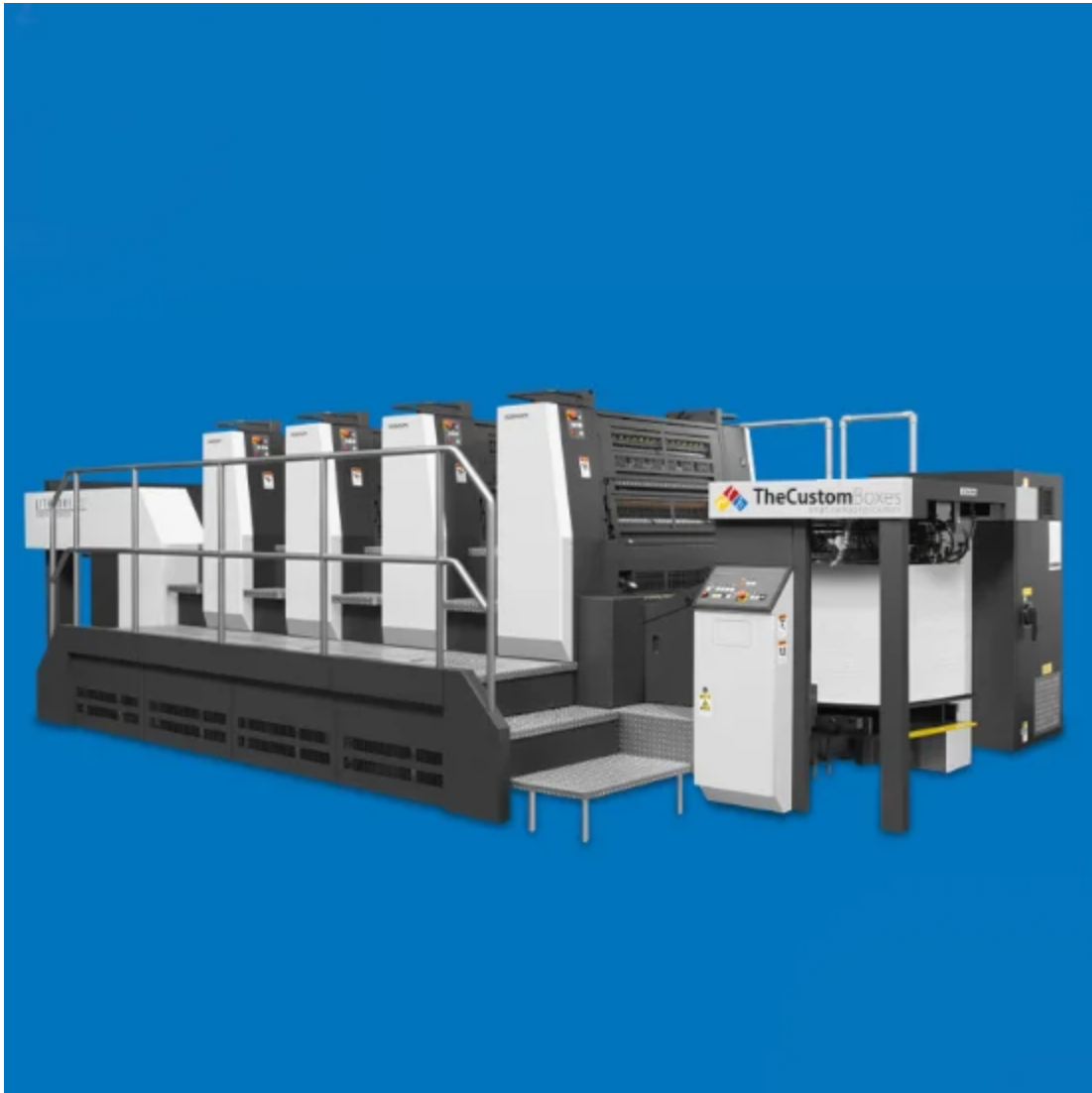

## industries

---

### One-shop for all industries Select Yours

---

Choose from an array of style and elegance exemplars at our extensive library. We give you complete freedom to shop by industry. Set your priorities before taking a look at our products. Cosmetics, Retail packaging, and CBD-specialized product boxes, everything is available at one store. Get a chance to avail yourself of our superfast yet perfect packaging in one go!

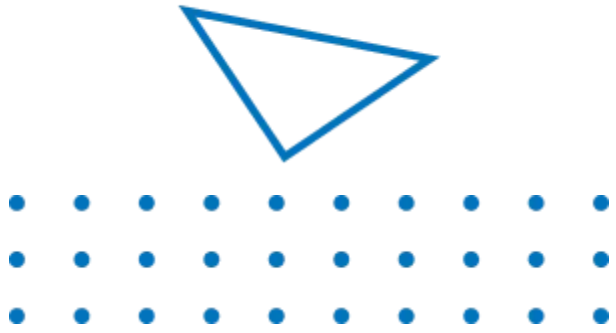

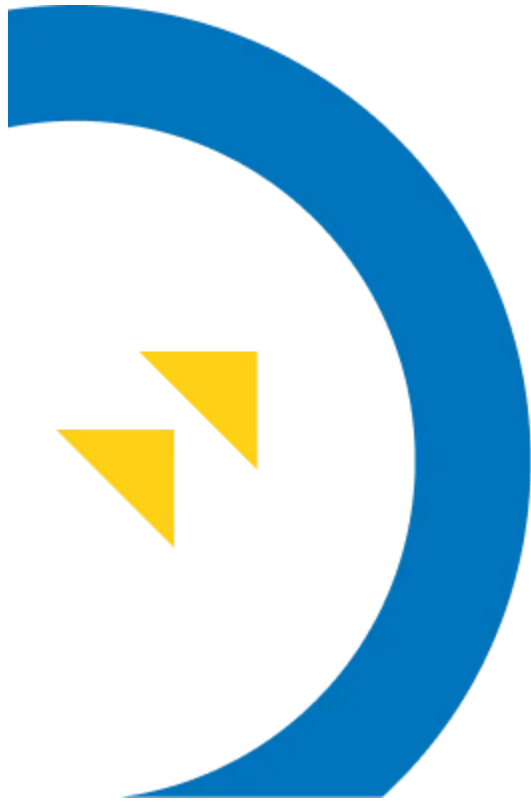





**Best seller**

---

### **Custom Retail Boxes**

---

For the majority, the whole business game revolves around the retail setting. It starts when your products are fashionably presented or displayed on shelves or ends when consumers select them. Custom retail boxes, with unique presentation and great printing, present even ordinary products exclusively. Our best-selling products like retail boxes are perfect to pose a go-go situation for all brands. Affordability and aesthetically, they enable you to have all

competitive edges. They are not mere packaging, they go beyond the tangible presentation of branding, and marketing. Get a perfectly crafted box that fixes your sizes, shapes, and color requirements.



**Best seller**

---

**Custom Boxes and Packaging**

---

Telling your brand tales on refined materials grabs the attention of customers. Custom box printing is the art of converting naturally derived materials into a box of perfection. Meticulously crafted custom package by experts' hands is completely spick and span. Spotless finishing with hues of charms adds charisma to your products. Majestic prints designed on purposeful patterns foster sales and build a brand. People love to have custom boxes and custom packaging as a brand statement to narrate their brand story.



## Best seller

---

### Custom Eco-friendly Boxes

---

We take immense pride in creating impressive boxes renowned for their ability to be recycled and biodegraded. Our custom packaging ideas, styles, and layouts are tailored to meet your specific needs, ensuring they are light on the planet. Surprisingly, you now have

the option to request unique patterns, figures, and external coatings for your boxes. Join us in making the Earth a better version through our commitment to crafting eco-friendly packaging solutions.



**Best seller**

---

**Custom Rigid Boxes**

---

Rigid boxes or set-up boxes are popular for their luxurious appeal. The rigidity of the rigid boxes is perfect for all delicate items. From gift-giving to great product launching, luxury boxes raise the bar in retail. Stay in memory of your customers with highly affordable packing boxes with logos. These little champions have become the biggest hit; exclusivity with elegance is the ultimate reason for their popularity. Let your brand glow with customized boxes for packaging- we made with high-end material. We are on radars, tell us what you want us to do for you.



## Best seller

---

### Custom Mailer Boxes

---

Our mailer boxes keep you ready to always facilitate your customers. It's a way to maintain a healthy relationship with clients in the best possible way. Stylish, durable, and ready-to-ship mailers are the best friends of all businesses. It is the most sought-after customize box

packaging for all. Whether you want to knock at customer's doors or send products to bulk purchasers, Mailers are real Wizards. These Unsung heroes take care of your products due to high resilience and tape-free interlocking. Stay in the queue to customize your mailers in any size, shape, or color.

## **Are you considering extravagant packaging for your business?**

---

Are you planning to make bulk custom box purchases from a single platform? The Custom Boxes caters to businesses across industries, assisting them in meeting high-volume packaging requirements.

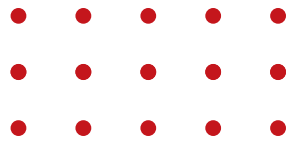





## **Build Your Brand with Customized Packing Styles That Grab the Spotlight**

---

We fully comprehend that packaging boxes not only present but also promote products effectively. Crafting a unique brand voice requires a fresh and innovative appearance. 'Box by Style' stands out as a distinctive feature on our official website, guiding you in selecting the perfect style for your delicate, high-selling items. Assemble various pieces of cardboard or other packaging materials to experience the final result. We infuse delight into every unboxing through exceptional interlocking. Explore creative concepts and captivate your customers with playful shapes without compromising functionality.

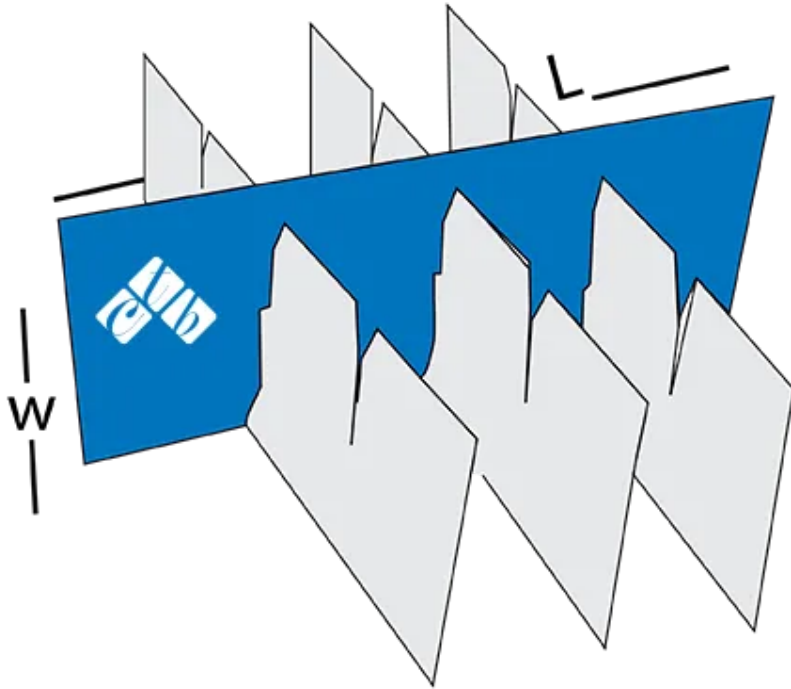

## Fence Partitions

---

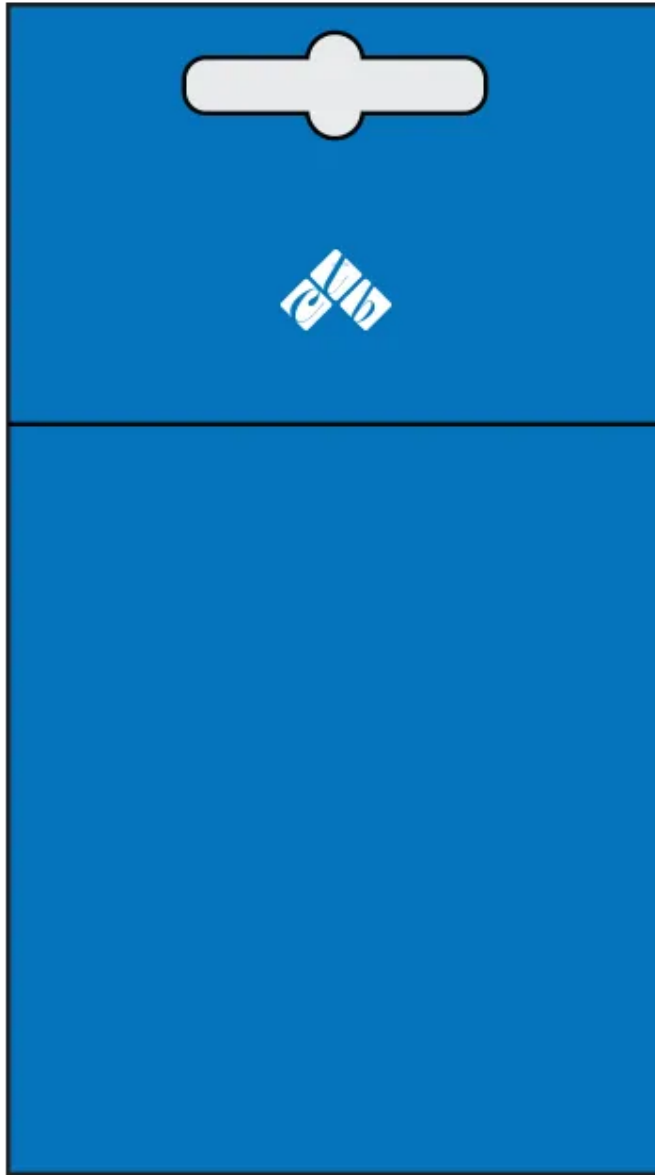

**Five Panel Hanger**

---

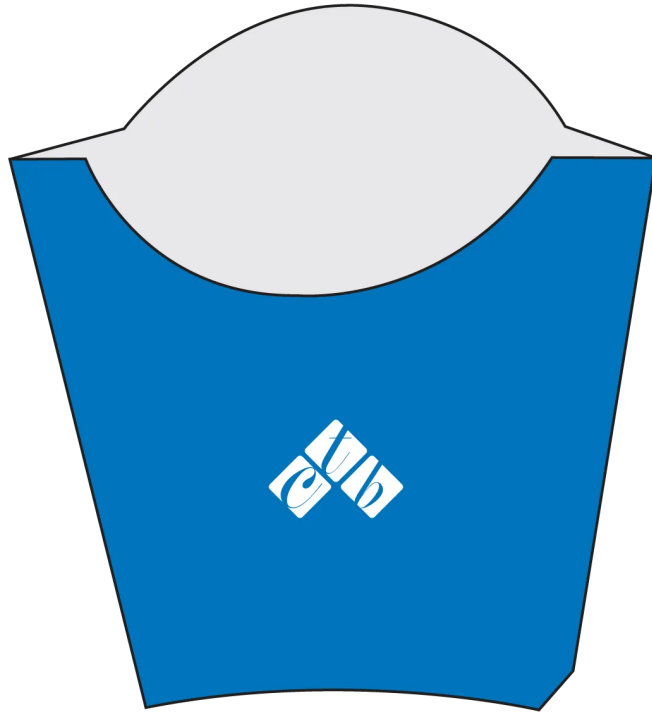

## French Fry Boxes

---

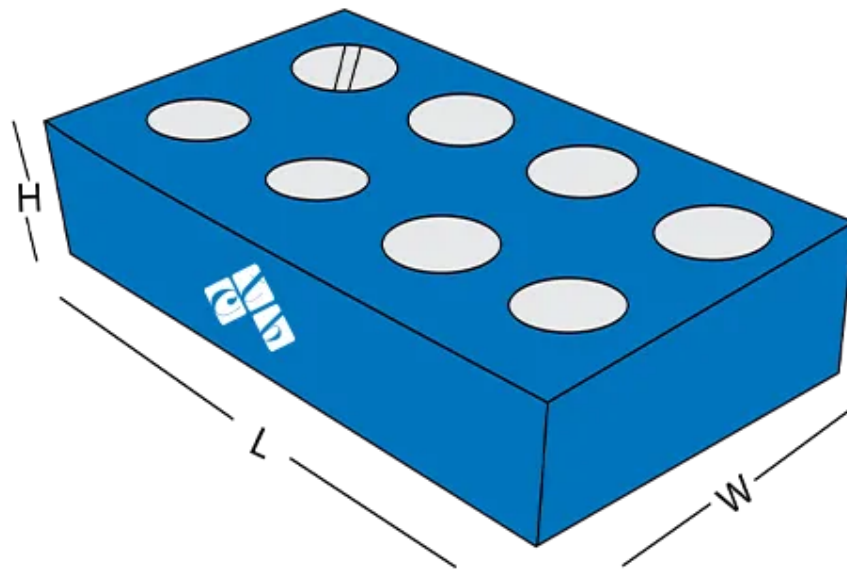

**Punch Partition**

---

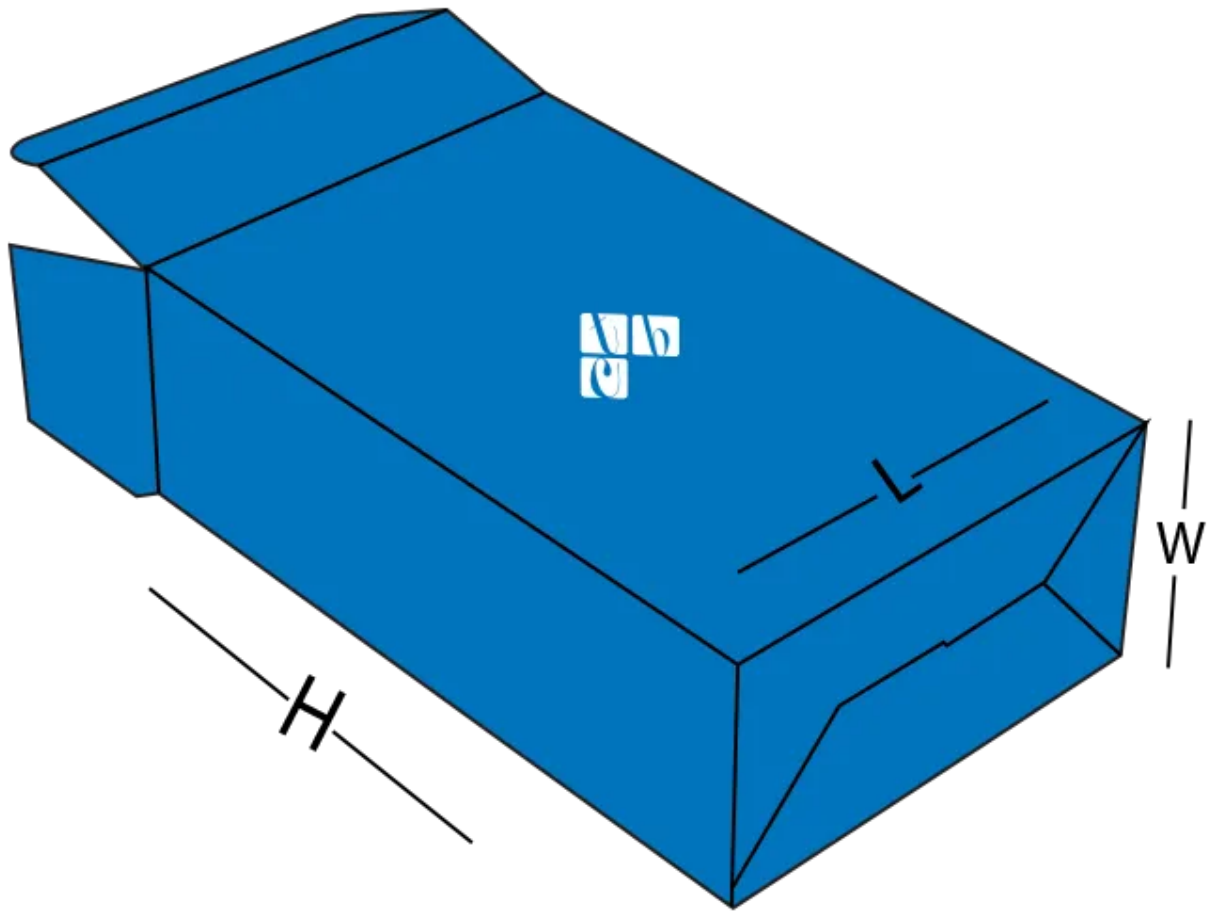

**Straight Tuck End**

---

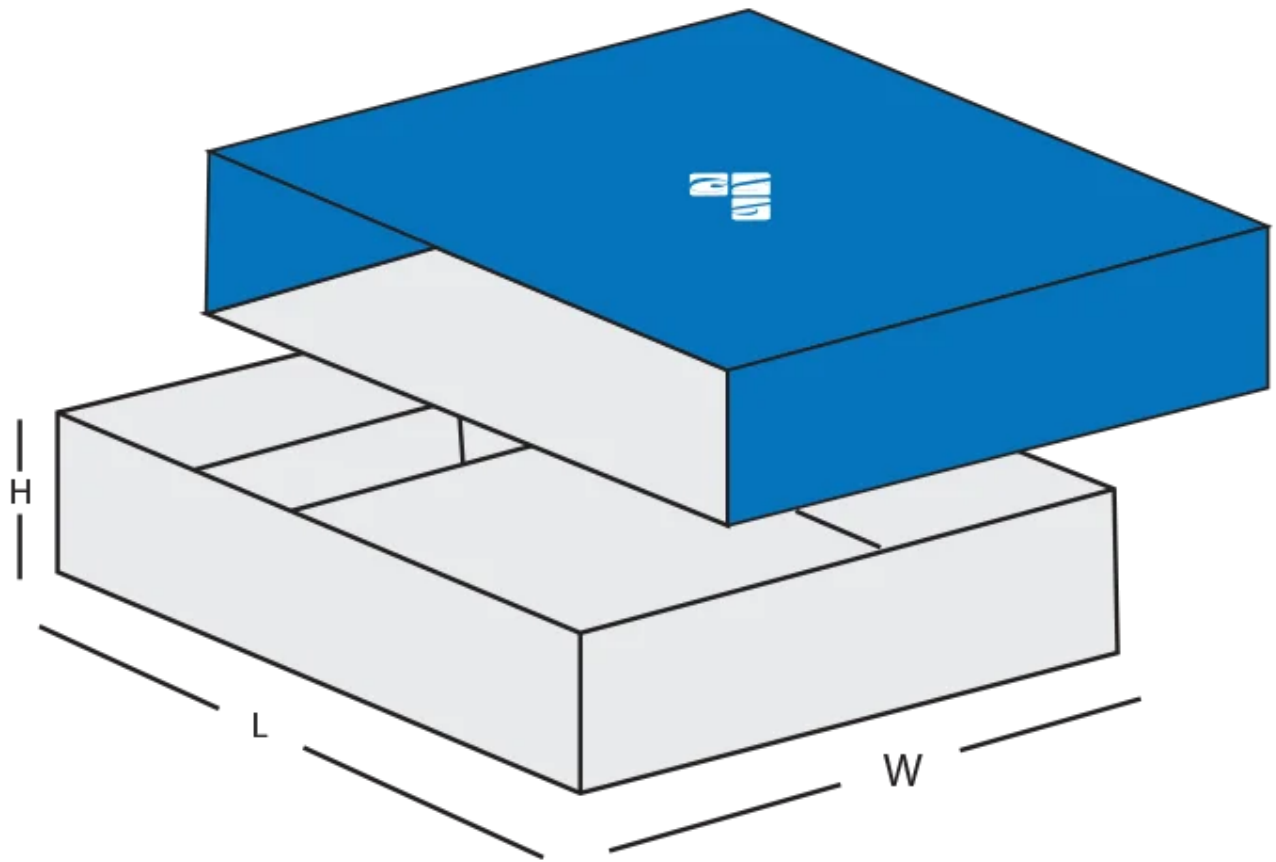

**Tray and Sleeve Box**

---



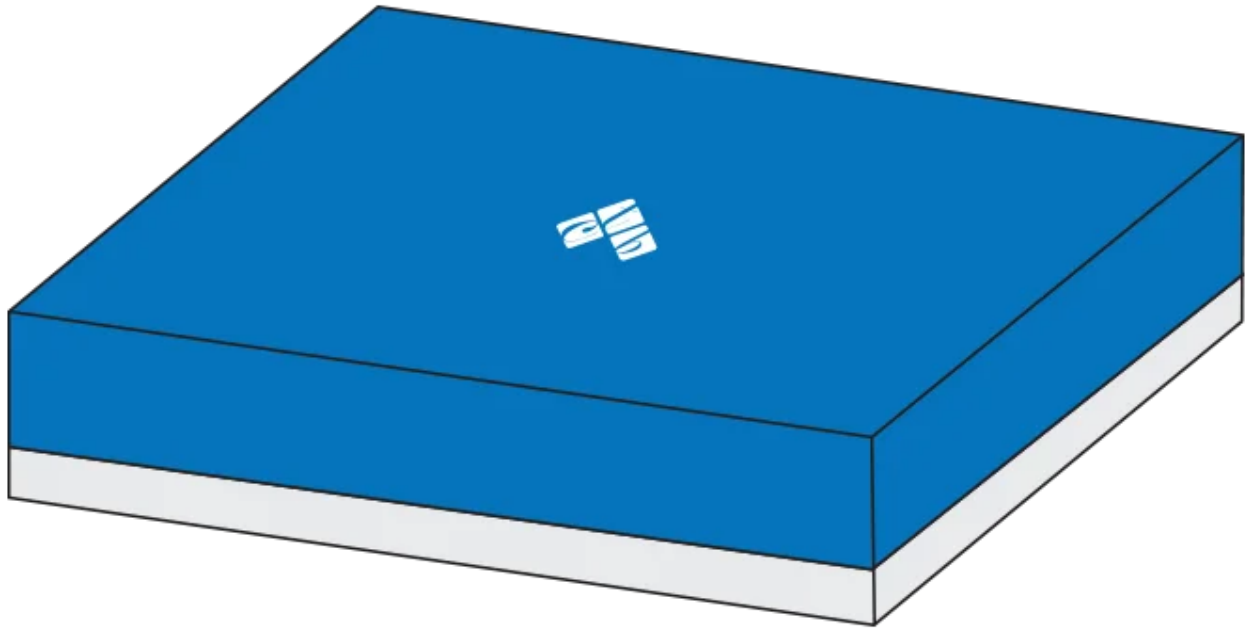

## Two Piece

---



## **Request a Prompt Response within 24 Hours**

---

Our hands-on involvement in customization enables us to provide extensive assistance to our customers. We are at your service and never disappoint you. To make the printing boxes customization easier than ever before, we invite you to fill out a Quote Request Form. Audio,

video, and real-time support for sharing your requirements further contribute to making the process hassle-free.



## testimonial's

---

### See Why Customers Love The Custom Boxes

---

We take pride in the unparalleled success of our packaging boxes, benefiting both retailers and wholesalers. When the ultimate goal is to exclusively serve with the hallmark of quality, we make it happen for you. Our top-tier packaging standards, without compromising your environmental concerns, set us apart. We've assisted hundreds of thousands of brands in propelling their businesses to success. Premium quality, coupled with affordability, illuminates the paths to success. But you don't have to take our word for it; consider the customer feedback and satisfaction rates.





31 Jan 2023

### The custom Boxes

---

I recently had the opportunity to work with The Custom Boxes, and I must say, their services were top-notch. From start to finish, they were professional, proficient, and attentive to my packaging needs. Their team is so friendly and does everything to make me feel valued. I am extremely satisfied with The Custom Boxes' services and will ord ... [Visit our Review Page](#)



### Kelly Green

---



31 Jan 2023

### The custom Boxes

---

I have been coming to the custom boxes for 2 years now— and they have been with me every step of the way on my journey in business!! They are super reliable, quick turnaround, and very personable people who responded so quickly and efficiently. Good vibes all around and love that they are located in Chicago near us ♥



### Alexis Davis

---



31 Jan 2023

### The custom Boxes

---

Since it was my first time coming up with my ideas, the process was a little challenging, but The Custom Boxes' talented staff was a huge help. They assist me in selecting the design trends that will draw in more customers and in sizing the boxes to the proper sizes. They also kept me informed about the procedure and shipping. Ultimately, I ... [Visit our Review Page](#)



**Ryan George**

---

[See All Testimonial's](#)

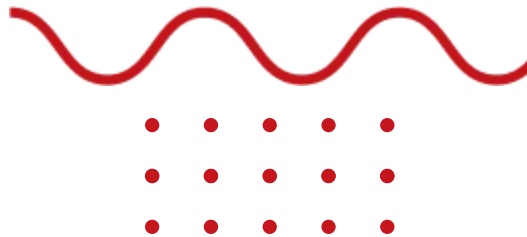

### Explore Artistic creations to cope with all Packaging Challenges

---

Pretty boxes have been the biggest contributors in shaping the US market. As a pioneer in the packaging industry, we have all vital ingredients under one roof to establish market dominance. The perfect fusion of expertise with plentiful resources enables us to deliver perfection professionally. Esteemed packaging with glitters of purpose turns ordinary wrapping into a lucky charm for your brand. Look no more, bespoke packaging awaits!

# gallery









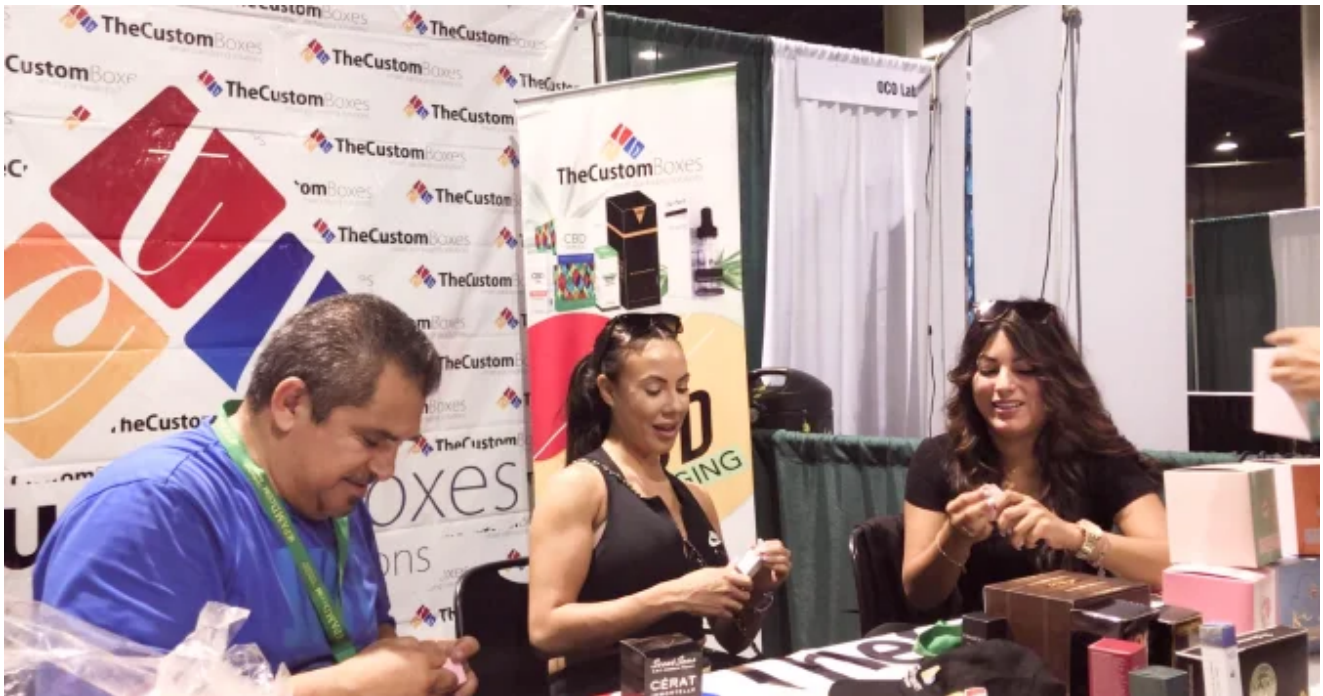















## Where you'll be

---

9933 Franklin Ave, Franklin Park, IL 60131

## Book Your Appointment With The Custom Boxes

---



Your Queries, Our Expertise

### **A single platform to manage your end-to-end packaging workflow**

---

Clear all your ambiguities to make an informed decision. Ask whatever you want, and we will provide answers to help you feel relaxed. Stop wondering, start exploring. Find answers below to create a clear mental picture of custom boxes.

---

To know the current status of your order, check your email where we send confirmation messages with tracking details at the time of order placement. Use the provided tracking number on the website to get the latest update about your order. Alternatively, you can also contact our CSRs. Our team can provide you with the most up-to-date information on your order. We feel pride in keeping our valuable customers aware of their current order status.

---

Just think of a thing you want to pack. You can get a customized box for it at The Custom Boxes. We offer a range of customizable packaging solutions including, display boxes, eco-friendly packaging, retail boxes, custom printed boxes, promotional packaging, custom inserts, cosmetic packaging, food packaging, custom labels and stickers, mailer boxes, and many more. Moreover, our specialized tailored packaging ensures to meet your particular product and branding needs.

---

Yes, we can print inside the boxes. Whether you want to print the interior side of a shipping box, product box, or tuck-top box, we offer customizable printing options to meet your requirements and preferences. However, our brown Kraft boxes can stand tall among many. With the printing of just a simple and delicate logo, they are ready to set the stage on fire.

---

Our QC department is specially created to check the quality of our packaging boxes before shipping. So, there is the least chance of receiving any faulty/damaged product. But if it still happens, unfortunately, then we take responsibility to compensate you as maximum as possible. For this, you have to follow a proper procedure. Submit your complaints within 7 working days after receiving the order. Our team will contact you at your earliest convenience. Send us back the damaged quantity on your behalf and we will happily replace them.

---

Our standard lead time is around 7- 10 working days. This lead time lacks transit time which is approximately 1-7 business days depending on your location. However, for complexly designed boxes and at extremely busy times of the year, some orders may take extra days. Your delivery date is estimated at the time of your order placement. If your order is time-sensitive then select our rush production option. It normally takes 4-6 business days for production.

---

Yes, we offer box mock-ups before actual production. We considered it necessary to ensure you how the actual product will look like. It also serves to visually showcase and test packaging designs before production. Moreover, we can send you a physical sample at a

minimal shipping cost so that you can assess and approve the final packaging design. However, we provide free samples in bulk quantities.

---

To print your boxes we use versatile printing methods. Printing can play a significant role in enhancing the overall appeal of your boxes. We hold expertise in digital printing, screen printing, and offset printing methods. Choose the one that better matches your preferences. Moreover, you can also go for embossing, de-bossing, metallic coating, or UV foil stamping for elevated aesthetics. If you are confused about selecting the appropriate printing method for your boxes, contact us. Our experts can help you mitigate your worries and assist you in selecting the most suitable option.

---

Choosing the right material for your custom boxes is a crucial decision because quality materials matter a lot in making your boxes sturdy and visually appealing. Start by understanding your own preferences and product requirements. Select from our wide range of available options such as cardboard, paperboard, Kraft paper, and many others. Our versatile and superior materials can assist you in achieving your desires and needs. Still, if you find it difficult, just contact our CSRs. They can provide you with assistance and make the selection process easy for you.

---

Yes, you can get your order done on an urgent basis. For this, you have to select the rush production option. It takes 4 to 6 days to deliver your orders to your doorstep. However, you have to pay slightly more to avail yourself of this opportunity. Our well-organized production rate and efficient shipping method make it possible to meet urgent order requirements, ensuring prompt delivery and a timely fulfillment process.

---

Yes, all our packaging boxes are composted because we craft them with sustainable materials such as cardboard, paperboard, or Kraft paper. Our focus on the use of compostable finishes or additives makes them environmentally friendly and conducive to composting practices. Incorporation of compostable elements into our packaging boxes is our initiative to minimize the environmental impact. So, our packaging boxes are the perfect choice for businesses seeking eco-friendly alternatives.

---

We are always looking to provide ease to our customers. For this, we ensure a smooth transaction process by offering a variety of convenient payment methods for packaging orders. Our accepted payment methods are usually based on online payment platforms. PayPal is our most common and frequently used payment method. To complete your order processing, it is recommended to deposit the mentioned amount through PayPal.



---

We offer a variety of prints on customized packaging. Whether you want minimalistic and classic prints or bold and sober patterns, we provide a diverse range of print and design options to cater to your specific and stylish preferences. With our high-quality prints, your customized packaging does not remain mere boxes to hold products; rather they become masterpieces that can hypnotize the sense of viewers.

---

Yes, you can get a sample of the printed box before placing a larger order. We know the significance of ensuring the quality and design to meet your expectations and requirements. Our priority to facilitate our clients as maximum as possible urges us to go the extra mile for their satisfaction. Therefore, we can discuss the possibility of providing a sample to help you make an informed decision. Also, our dedicated team is committed to facilitating your needs and fostering your trust in our products.

---

To determine the maximum size and capacity we can print, you can contact our customer service team. We provide a wide spectrum of printing capabilities tailored to your specific needs. Our expert and knowledgeable staff can assist you by providing detailed information on size specifications, printing facilities, and customization possibilities based on the type of packaging you select. Directly discuss your project details with us so that we can ensure that the printed boxes meet your required size and capacity. However, we do print more than 5,000 boxes easily for an order.

---

## **Seek Assistance? Start One-to-one conversations**

A subtle hint of doubt can restrain a business from witnessing a boom. Clear your ambiguities and clean-bold competitors to win your business game with The Custom Boxes.



## Custom Boxes - Excellence For Existence

---

*The Custom Boxes* has opened new doors of possibilities to **personalized box packaging**. We assure quality to quantity in terms of designs, printing, and outlook of boxes of all types. Our enticing color palette for digital and offset printing technologies allows us to provide superb-quality packaging boxes. Pick up the box material and graphics you want us to craft for your wide variety of products. Getting **custom box printing** services at such an affordable price has never been as easy as it is with one of the World's biggest packaging companies. We are assisting thousands of businesses in getting their unique products packed in artistically designed bags or boxes. We allow each of your products to get noticed by potential customers with an array of add-ons and finishing options for your **custom**

**packaging boxes.** We are an ardent supporter of green eco-oasis; all our boxes are made from 100% recyclable materials. We offer our worthy clients premium promotional and branding boxes, setting themselves apart from others. We are pioneers in creating custom logo boxes with eye-catching, and compelling taglines.

More than a decade of hands-on experience has made us a top-notch packaging service provider preferred by stellar brands. [Fill in the form to get started now!](#) Our Customer Services Representatives are available 24/7 to entertain your queries and concerns. Let us be your trusted packaging partner of all tough times. Feeling difficulty in choosing the right box design to merchandize your product line? Chat with us and transform your specifications into a reality. Build a box now!

## Custom Packaging Boxes: Protect, Prioritize, And Promote

---

How to make a 'forerunner product box' to produce massive sales? The role of custom packaging in protecting, prioritizing, and promoting your products over others reveals the mystery. **Boxes and packaging** created by *The Custom Boxes* are created to shine and captivate customers. With ceaseless customization of package box styling and design ideas, we make your products the real McCoy. We promote automation of designs, printing, and branded packaging for good looks and to streamline efficiency. Decorative packaging, meticulously crafted by the skillful hands of our highly polished staff, luxuriates your boxes appeal. Creating **packaging for business** seems as effortless as a breeze, but it involves strategic planning, meticulous attention to detail, and awareness regarding the latest market trends. Our well-equipped factories and state-of-the-art technology keep the spark of your products alive, even behind the layers of paperboard. Our **personalized boxes** mirror your commitment to excellence, amplifying brand value. Adored with copyright tags, QR codes, and trademark symbols, **Custom printed packaging** win customers' trust, track inventory, and protect intellectual property.

Starting from designing, assembling, printing, die cutting, lamination, and pasting, we achieve 100% perfection to enhance natural aesthetics of packing boxes. **Customized boxes** are utilized worldwide in order to accomplish different purposes, the most common of them is to make them "Fit for the product". It influences a strong brand image, facilitates shipping, and displays items of all kinds ranging from decorative to electronic and surgical items. Our **custom packages** boxes are manufactured in-house by promising care and attention so that customer requirements are fulfilled at every step. We offer competitive rates coupled with a steadfast commitment to ensuring the best quality services among all **custom packaging companies** near you. Discounted packaging box prices with unrivaled quality assurance practices make us the ultimate solution to all queries like where to buy packing boxes. We craft boxes for everyone! Our wallet-loving discount offers are the talks of town. Hurry up! Snatch it before it slips away!

## Custom Boxes With Logo- Good-To-Go For All:

---

Is your selling journey still revolving around queries such as what's trending now? How to grab the attention of customers? What makes your brand one in millions? How to be quickly followed by millions? Or others. Don't sweat over the small stuff. We are here to show you the right path by instantly knowing what's inside your mind and always coming out with a design that connects you with your customers. Have a look at what we have to put on your **branded boxes**:

1. Material - Durable Yet Environment Friendly
2. Styles- Captivating And Breathtaking
3. Prints (**custom printed boxes**)- Artistic Yet Elegant
4. Sizes- Innovative Yet Functional
5. Embellishment- Sense Of Luxury And Sophistication
6. Laminations- Additional Protection And Polish Finish
7. Holographic- Mesmerizing And Futuristic Images

Customization turns standard corrugated, Kraft, and even cardboard boxes into a perfect fit for your brands. We- while enjoying the status of the **best custom box Manufacturers in USA**, believe nothing other than a simple box with a logo can be as powerful marketing tool, addressing all business problems quite smoothly. Just by a pinch of creativity and professionalism to apparently simple-looking boxes, custom printed boxes would start telling a story. People love to listen to stories- especially motivational stories. So, why not amuse people with what they want to listen to? Create **custom box packaging** to put life into your brand's story.

Let's zero in on the straightforward details about how typical custom boxes for packaging will be a magical addition to your company. *The Custom Boxes* team, in compliance with our commitment to excellence, is debunking all myths of packaging. Even Our cheaper boxes are also made as per International Packaging standards or simply they are unparalleled as far as quality is concerned. Likewise, **rigid boxes**, magnetic closure boxes, cardboard boxes, offset or digitally printed luxurious boxes, and other **custom-made boxes** are themselves signs of quality. Long story short, from cheaper to all exclusive varieties in packaging, all customizable boxes are tailored to boost business revenue.

**Custom printed boxes** and your products are just made for each other- from shapes to size, prints to designs, and cost to delivery, we ensure ease in every step. Featured unboxing aims to offer style with functionality alongside an outstanding outlook, compelling people to add your product to carts. The levels of detail and artistry of every box custom printed box are truly remarkable- capable enough to give you a competitive edge.

To all incredible business owners and manufacturers, *The Custom Boxes* is a one-place solution for all your packaging needs. **Order custom packaging** at a rate nobody else is offering and get yourself to avail the best industry-specific packaging. Just mark your identity for pursuing a sustainable business journey with us.

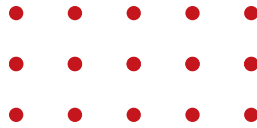

## blog

---

### Learn about Custom Designer Boxes From The Pros

---

We assist you in getting the nitty-gritty of packaging and customized boxes for businesses. Delve Deep into the depth of the customization process to opt for the trendiest design, prints, and technologies. Go ahead! We are right at your back!